



Chip Trimmer Capacitors

High Quality Product VER 2.0



C.T.C Applications

- Two-way Radio Communication [FRS, GMRS, LMR]
- Remote Keyless entry system
- Wireless Hands Free
- Wireless Door lock
- Security System
- Cordless Phone
- Radar Detectors
- CCTV Camera
- RF Module
- Car Audio
- Car Horn
- RFID
- DVD



■ STC3M SERIES Specification / STC3M 系列详细说明书

型号 ITEM	STC3MA03	STC3MA06	STC3MB10	STC3MD20	STC3ME30
	3pf	6pf	10pf	20pf	30pf
	黑色 Black	蓝色 Blue	象牙色 Ivory	粉红色 Pink	绿色 Green
模型 Model					
容量(pF Min) Capacitance(pF Min)	1.5max	2.0max	3.0max	5.5max	8.0max
容量(pF Max) Capacitance(pF Min)	3.0 $\begin{smallmatrix} +50\% \\ -0 \end{smallmatrix}$	6.0 $\begin{smallmatrix} +50\% \\ -0 \end{smallmatrix}$	10.0 $\begin{smallmatrix} +50\% \\ -0 \end{smallmatrix}$	20.0 $\begin{smallmatrix} +50\% \\ -0 \end{smallmatrix}$	30.0 $\begin{smallmatrix} +50\% \\ -0 \end{smallmatrix}$
微调容量(Max) Capacitance Drift(Max)	±2%	±2%	±2%	±3%	±3%
温度系数(ppm/°C) Temperature Coefficient	NP0±300	NP0±200	N600±400	N900±400	N1200±300
Q值 Q Value (at 1 MHz, C max)	300Min	500Min	700Min	500Min	300Min
绝缘电阻 Insulation Resistance	10 ⁴ MΩMin	10 ⁴ MΩMin	10 ⁴ MΩMin	10 ⁴ MΩMin	10 ⁴ MΩMin
额定电压 DC Rated Voltage	100VDC	100VDC	100VDC	100VDC	100VDC
耐电压 DC Withstanding Voltage	220VDC	220VDC	220VDC	220VDC	220VDC
REACH(SVHC) 测试 REACH(SVHC) Test	Complete				
操作温度 Operation Temperature	-25°C to 85°C				
调试力矩 Rotation Torque	15 ~ 72 gf.cm				



▪ Chip Trimmer Capacitor 贴片型陶瓷可调电容

Features 产品特点

- Low capacitance drift / CTC的容量变化很小
- Keep reliable quality after toluene cleaning / 可以用甲苯洗涤产品
- Easy reading of the capacitance with color-code / 根据产品的颜色就很容易判断出产品的容量
- High durability from vibration, dust, moisture and flux / 性能稳定, 不易受外部环境影响(振动、灰尘、湿气和助焊剂)
- Small size with external dimension of 3.2[W] x 4.5[L] x 1.5[H] mm for STC3M SERIES
2.5[W] x 3.4[L] x 1.2[H] mm for STC2M SERIES
超小型 STC3M系列 (3.2[W] x 4.5[L] x 1.5[H] mm)
超小型 STC2M系列 (2.5[W] x 3.4[L] x 1.2[H] mm)
- Designed for reflow soldering [surface mount applications] / 重新设计产品以适应自动焊接生产工序 (SMT)

Part Numbering

S **TC** **3M** **A** **06-** **T**

① ② ③ ④ ⑤ ⑥



- ① SEHWA Company Name
- ② Trimmer Capacitor
- ③ Product Size [MOLD] 3M : 3mm
2M : 2mm
- ④ Temperature Coefficient [ppm/°C]
A : NP0 B : N600 C : N750 D : N900 E : N1200
- ⑤ Nominal Maximum Capacitance
03 : 3pf 06 : 6pf 10 : 10pf 20 : 20pf 30 : 30pf
- ⑥ Packing Method T1 : 1,000 pcs/reel [12mm Tape & Reel]
BO : Bulk Type



STC3M SERIES Dimensions & Soldering Conditions

STC3M系列产品规格 & 焊接条件

Tape and Reel Specifications / 料带尺寸

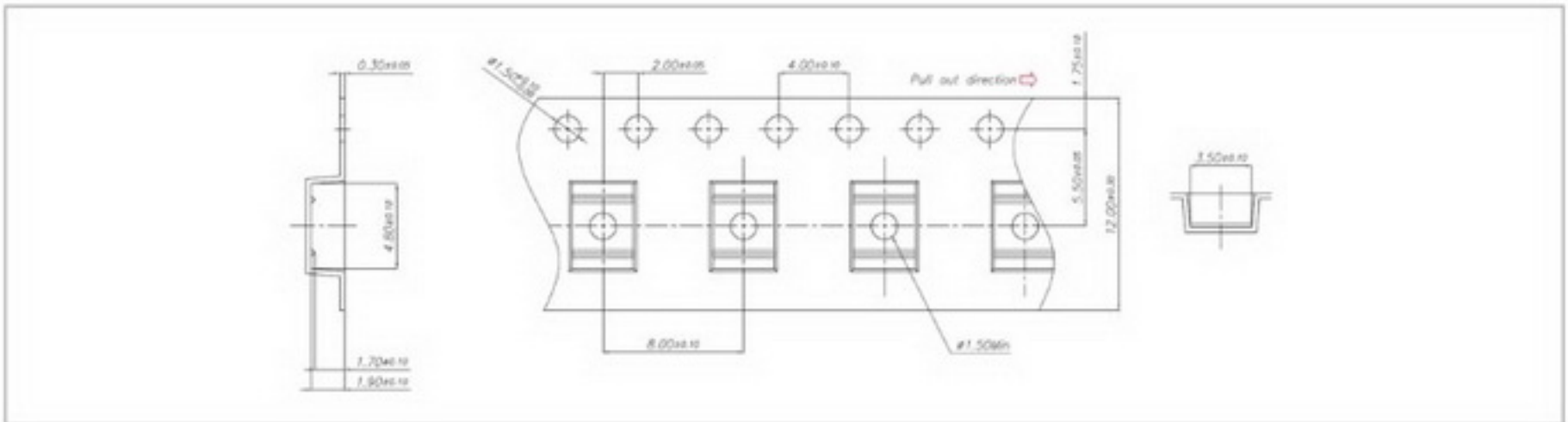

Dimensions / 外形尺寸

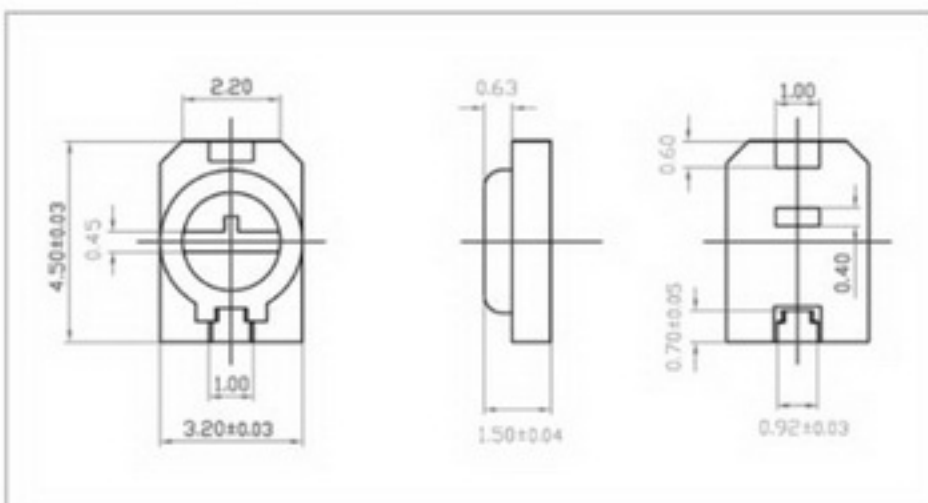

Land Patterns

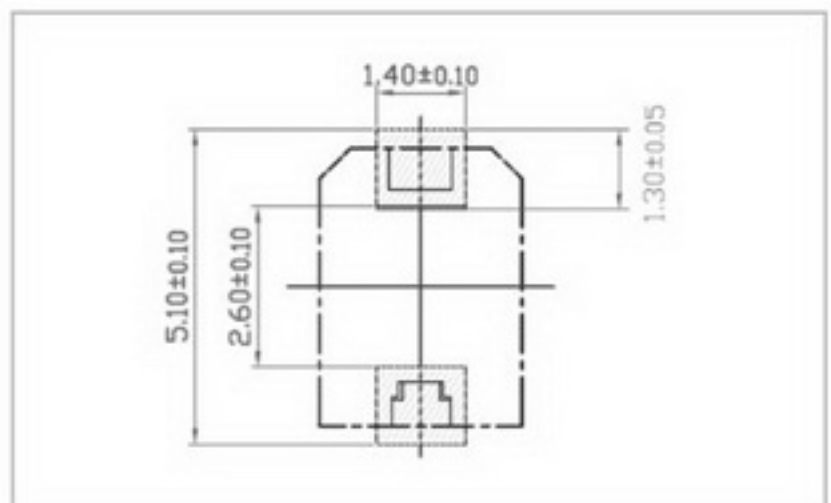

Standard Soldering Conditions / 标准焊接条件

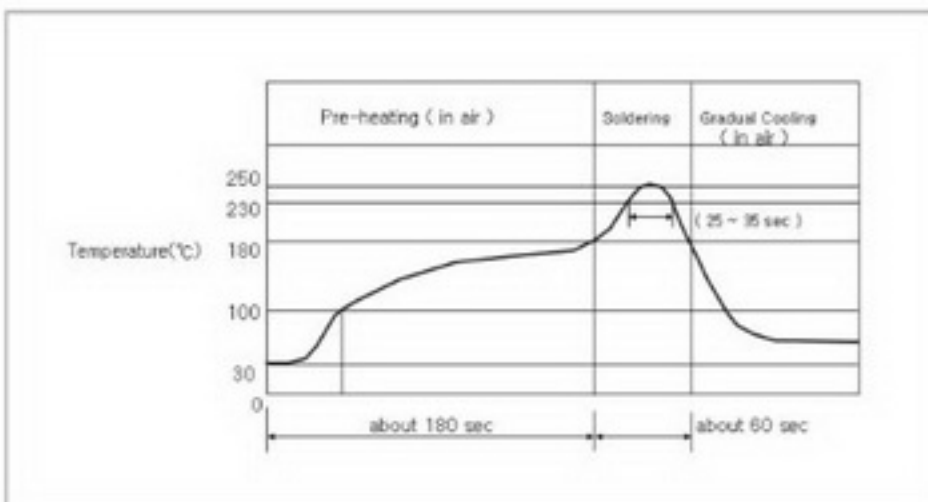

Recommended Tuning Tools / 推荐的调试工具

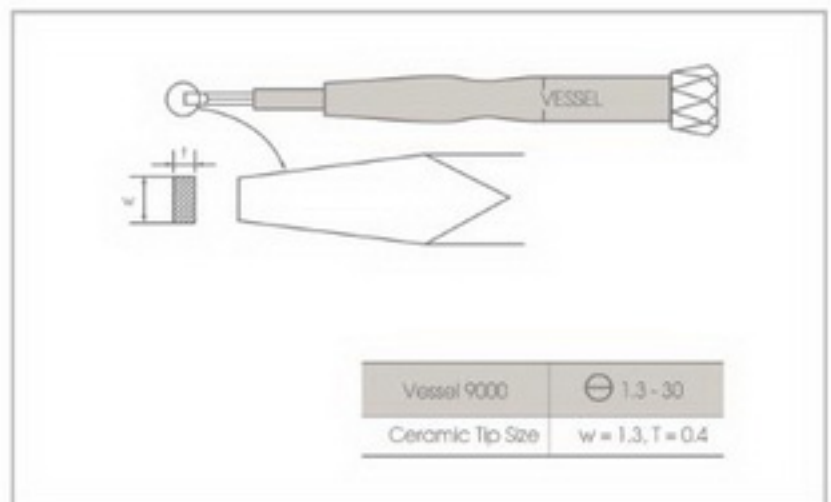



STC3M SERIES Frequency Characteristics STC3M系列频率特性

Capacitance vs Frequency Curve
容量与频率特性曲线

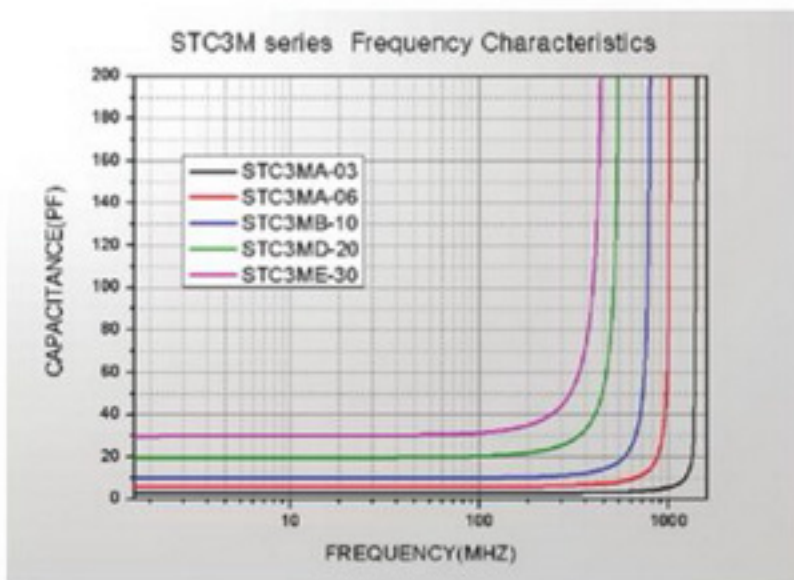

Self-Resonant Frequency Curve
自谐振频率曲线

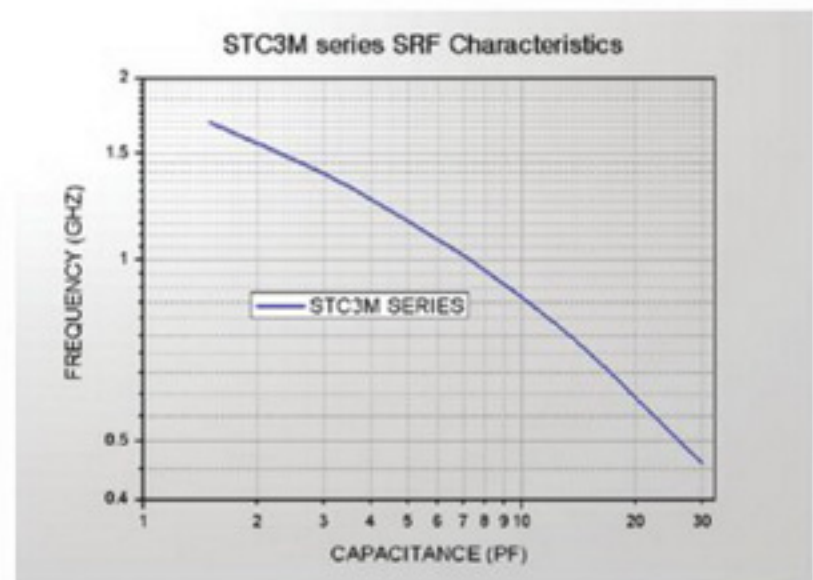

Q Values vs Frequency Curve
Q值与频率特性曲线

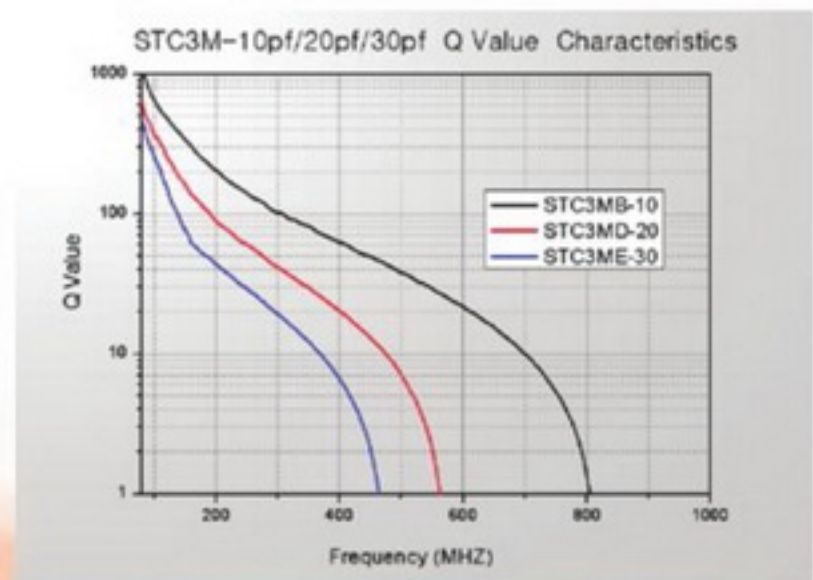
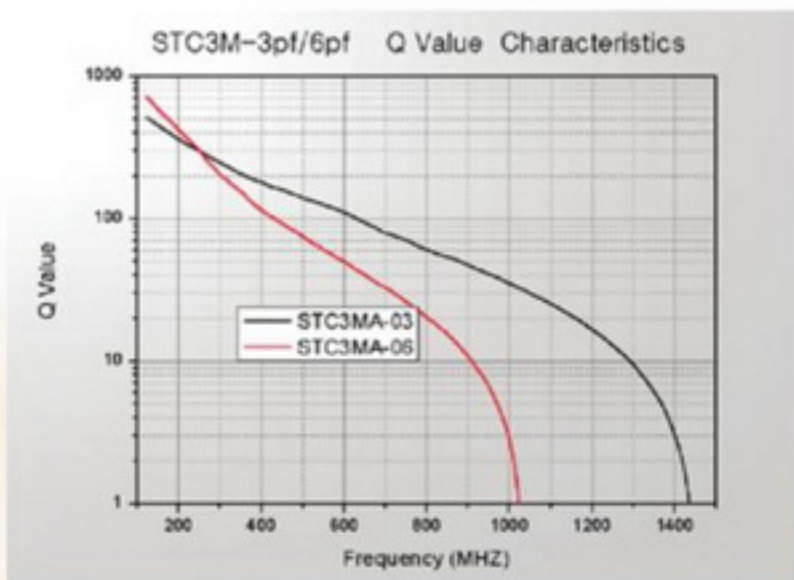



▪ STC3M SERIES Temperature Characteristics STC3M系列温度特性

