

REV.	EGN.NO.	MODIFY CONTENT	DATE
A		NEW	2016/03/13

**Notes:**

**Material: Phosphor Bronze(C5191-H)**

SIMM Card Connector, With

Cover, Type 1, 8 Pin

Physical:

Housing: LCP UL 94V-0

Contact: Selective Gold Flash

Specifications:

Voltage Current rating: 1A, 50V AC

Insulation Resistance: 1000Mohm Min

Contact Withstanding Voltage:

AC 500V For 1 Minute

Temperature Rating: -40° To +85°

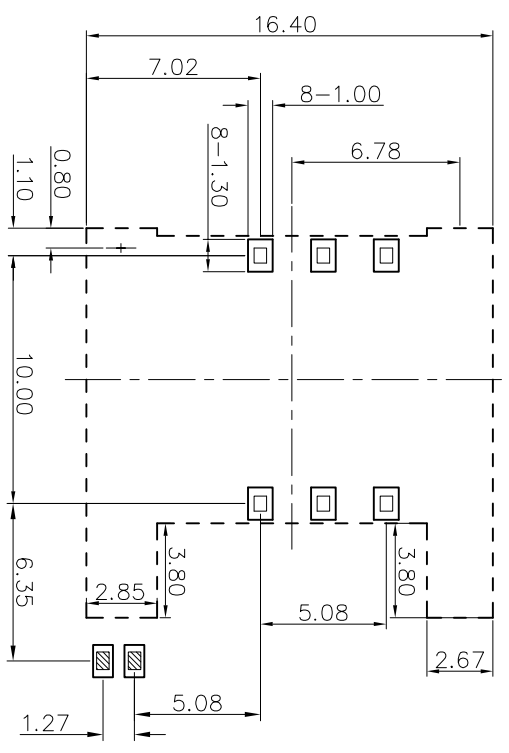
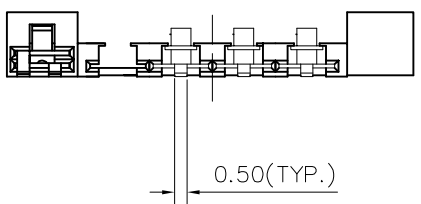
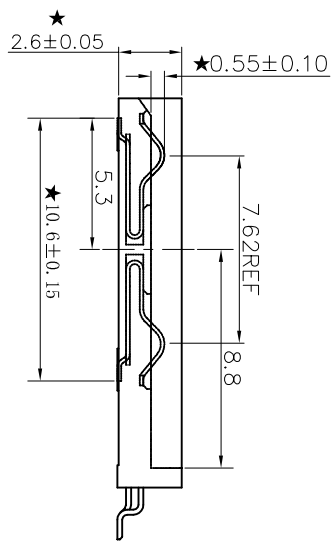
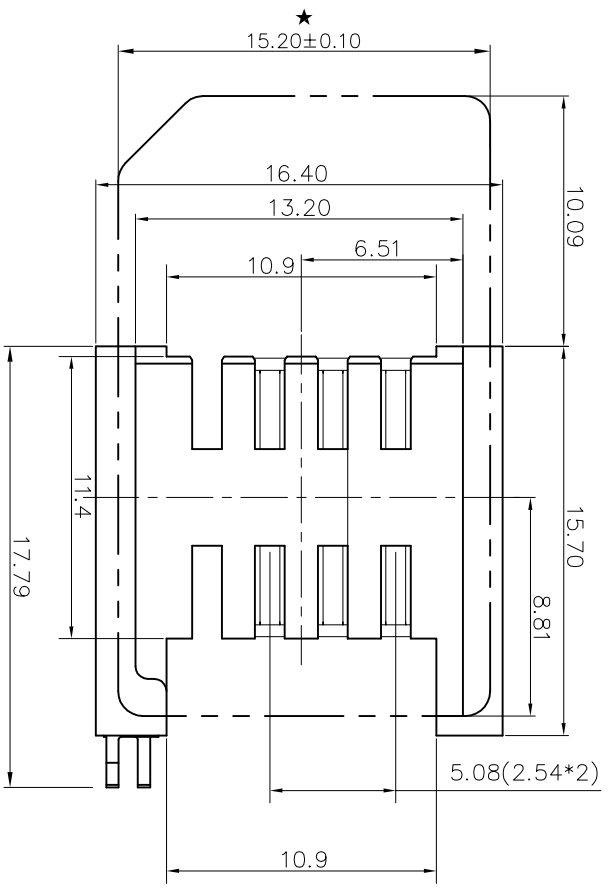

REFERENCE PC BOARD LAYOUT

GENERAL TOLERANCE		DWG NO.	JYSA1603-001	APPD:	WIND	Scale	1:1
X±0.45	X:±5°	Title	SIMM 6PIN 2.54(端子间距/带开关)	CHKD:		UNIT	mm
X±0.35	X:±2°	Part NO.	JYS-SIM260-173	DR:			
.XX±0.25	.XX'±1°	Date	2016/03/13				
.XXX±0.15	.xxx'±0.5°						
SHEET	1/2						



REV.	ECN.NO.	MODIFY CONTENT	DATE
A		图面首次发行	2016/03/15

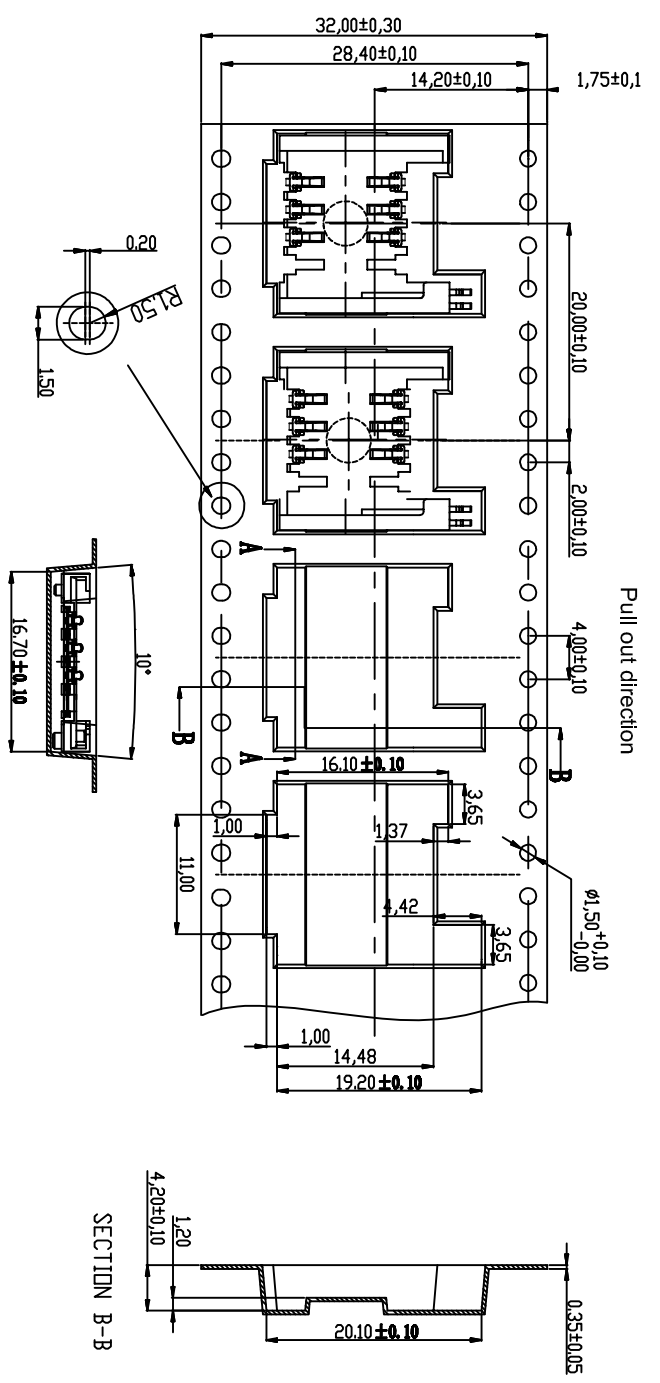

5.1.2 Reel Form Diagram

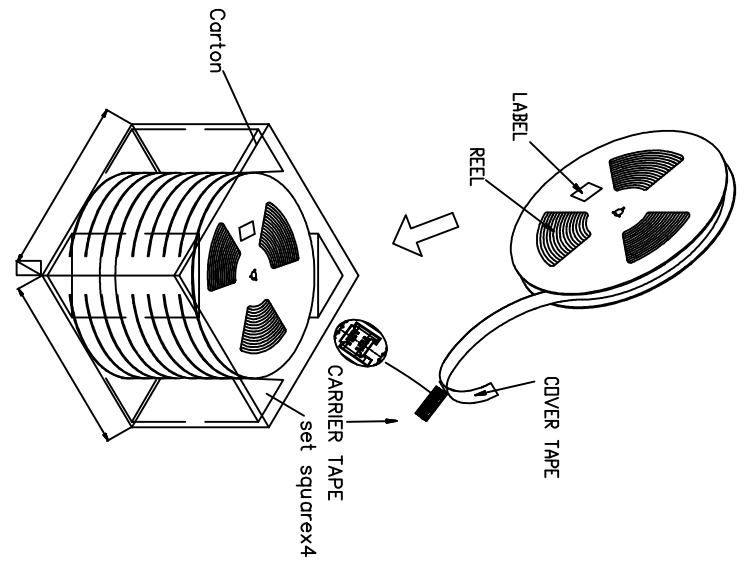
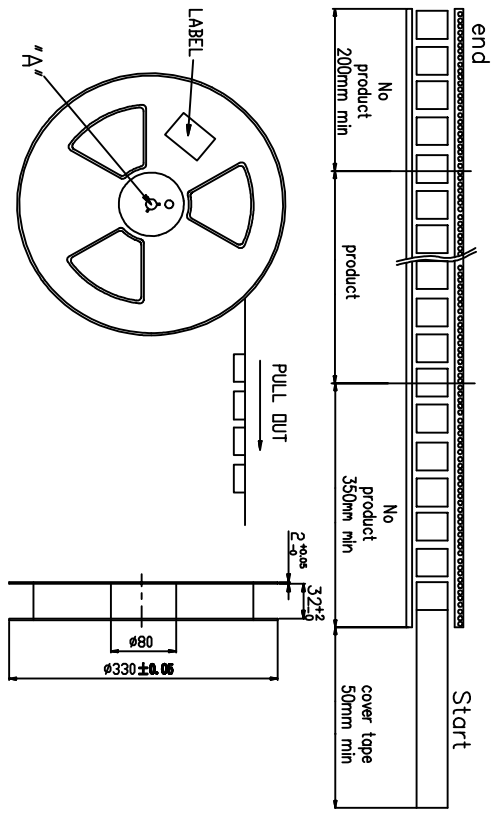

G.W:0.78 KG  
 Q'ty:800 pcs/Reel  
 N.W:7.8KG  
 G.W:9.6 KG  
 Q'ty : 8000 pcs per Carton (10 Reel set in order)  
 Meas : 34.5L x34.5W x38.5H cm

GENERAL TOLERANCE		图号	JYSA1603-001	设计	彭善平	比例	1:1
X±0.45	X:±5°	品名	SIM 8PIN 2.6H(端子短脚/带开关)	审核		单位	mm
X±0.35	X:±2°	料号	JYS-SIM260-173	核准			
.XX±0.25	.XX:±1°			日期	2016/03/15		
.XXX±0.15	.xxx:±0.5°						
页号	2/2						

JYS 杰宇森电子有限公司  
 JIE YU SEN ELECTRONIC CO., LTD.