

REV.	ECH.NO.	MODIFY CONTENT	DATE
A		NEW	2011/10/31

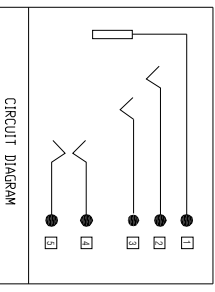
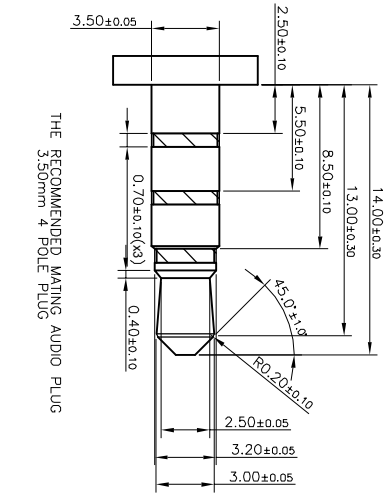
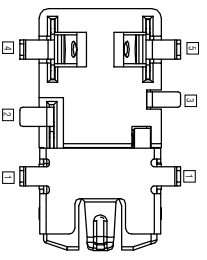
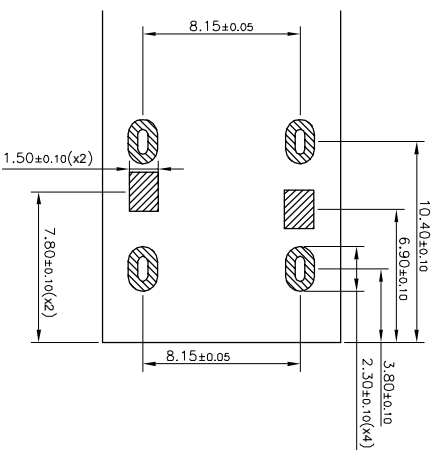
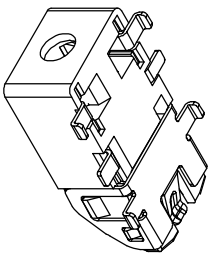
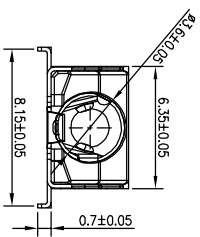
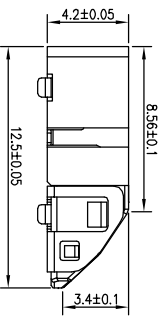
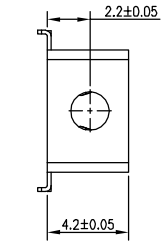
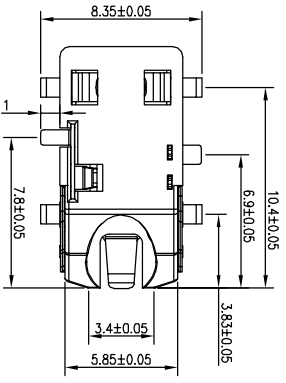

THE RECOMMENDED MATING AUDIO PLUG
3.50mm 4 POLE PLUG

- NOTES :
- 1.0) RATING :
 - 1.1. VOLTAGE : 12 VDC (R.M.S.)
 - 1.2. CURRENT : 1 AMPERE MAXIMUM PER CONTACT AT 30°C T-RISE
 - 1.3. TEMPERATURE : -25°C TO +85°C
 - 2.0) ELECTRICAL CHARACTERISTIC
 - 2.1. CONTACT RESISTANCE : INITIAL 50m Ω MAX. AFTER 100m
 - 2.2. INSULATION RESISTANCE : 100 M Ω MIN.
 - 2.3. DIELECTRIC WITHSTANDING VOLTAGE : 500 VAC AT SEA LEVEL
 - 3.0) MECHANICAL :
 - 3.1. DURABILITY ,MINIMUM: MATED 5000 CYCLES WITHOUT DEGRADING ELECTRICAL
 - 3.2. INITIAL-MATING FORCE: 300g~2000g; UNMATING FORCE: 200g~2000g
 - 3.3. AFTER LIFE TESTING-MATING FORCE: 300g~2000g; UNMATING FORCE: 200g~2000g

GENERAL TOLERANCE		DWG NO.	JYSA0319-001	APPD.	WMD	Scale	1:1
X.±0.45	x.±5°	Title	PHONE JACK	CHKD:		UNIT	mm
X±0.35	x.±2°	Part NO.	JYS-JK420-017	DR:			
.XX±0.25	.xx'±1'	Date	2011/10/31				
.XXX±0.15	.xxx'±0.5'						
SHEET	1/1						



杰宇森电子有限公司
JIE YU SEN ELECTRONIC CO., LTD.