

REV.	EGN.NO.	MODIFY CONTENT	DATE
A		NEW	2018/10/31

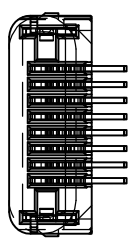

GENERAL TOLERANCE		DWG NO.	APPD:	WIND	Scale
X±0.45	X:±5°	JYSN1014-03			1:1
X±0.35	X:±2°	Title	CHKD:		UNIT
XX±0.25	.XX±1°	Part NO.	DR:		MM
.XXX±0.15	.xxx±0.5°		Date		
SHEET 1/1					

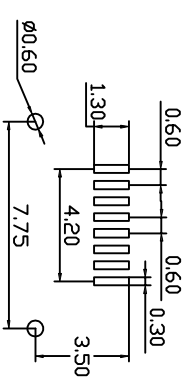
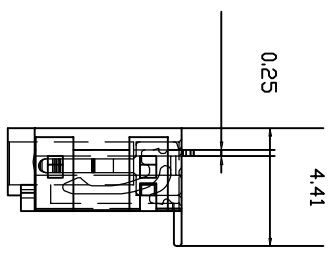
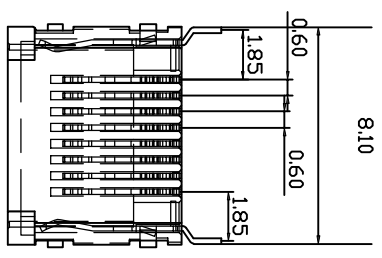
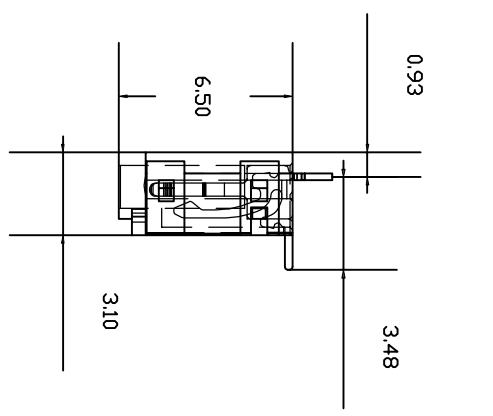
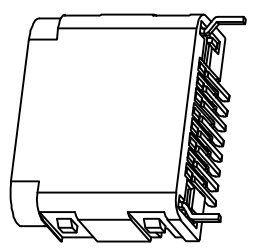
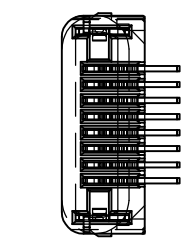

深圳市杰宇森电子有限公司
Shenzhen JieYuSen electronic co., LTD.